

Article number: 20194B45B452SW

Description: E+G

T-angel clamps GN194-B45-B45-2-SW

## Measures

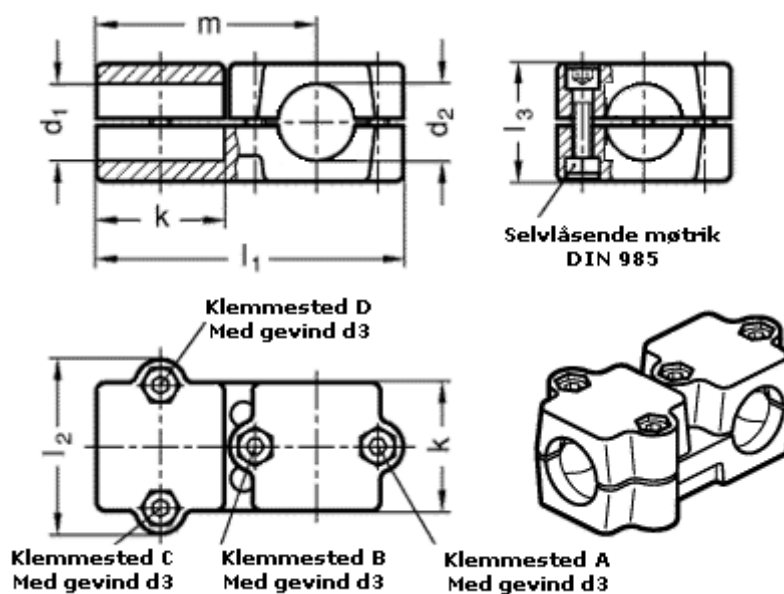

d1 = 45  
d2 = 45  
d3 = M10  
k = 76  
l1 = 176  
l2 = 98  
l3 = 70  
m = 126